

芯位排布 Core layout	 A-CODE 3P	 A-CODE 4P	 B-CODE 5P
额定电压/电流 Rated voltage/current	50V AC/60V DC 3A	50V AC/60V DC 3A	30V/3A
芯位排布 Core layout	 A-CODE 6P	 A-CODE 8P	
额定电压/电流 Rated voltage/current	30V/1.5A	30V/1.5A	

发行版本 Revision	修改内容 Description	制图 Drawing	日期 Date
A / 0	First release	Ding	2023.05.27

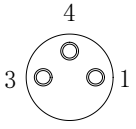
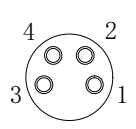
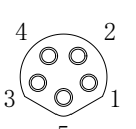
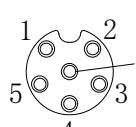
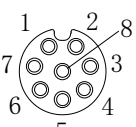
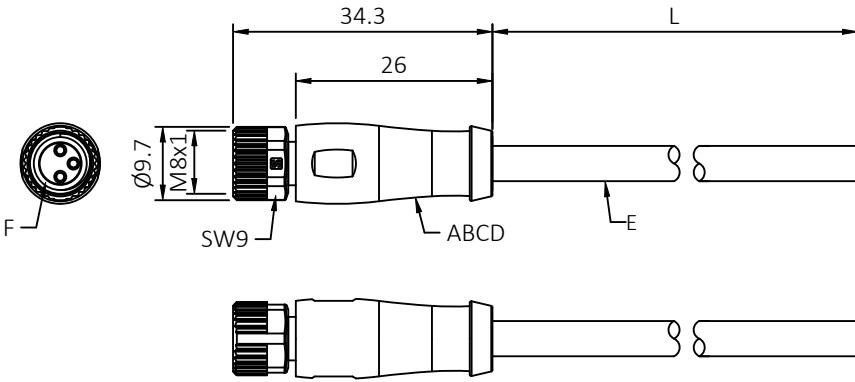

Pin Assignment

芯数 (PINS)	3芯 (3PIN)	4芯 (4PIN)	5芯 (5PIN)	6芯 (6PIN)	8芯 (8PIN)
芯线规格 Wire gauge	24AWG (0.25mm ²) x3C	24AWG (0.25mm ²) x4C	24AWG (0.25mm ²) x5C	26AWG (0.15mm ²) x6C	26AWG (0.15mm ²) x8C
Pin 1	棕色 (brown)	棕色 (brown)	棕色 (brown)	棕色 (brown)	白色 (white)
Pin 2		白色 (white)	白色 (white)	白色 (white)	棕色 (brown)
Pin 3	蓝色 (blue)	蓝色 (blue)	蓝色 (blue)	蓝色 (blue)	绿色 (green)
Pin 4	黑色 (black)	黑色 (black)	黑色 (black)	黑色 (black)	黄色 (yellow)
Pin 5			灰色 (grey)	灰色 (grey)	灰色 (grey)
Pin 6				粉色 (pink)	粉色 (pink)
Pin 7					蓝色 (blue)
Pin 8					红色 (red)

- 可选尾部处理 Optional tail processing:
1. 可客户要求定制 Can be customized by customers
 2. 尾部平切 End cut
 3. 去外被镀锡 Peeling and tin plating
 4. 接其他类型连接器 Connect to other types of connectors

技术参数 Technical specifications	
绝缘阻抗 Insulation Resistance	≥100mΩ
接触阻抗 Contact Resistance	≤5mΩ
工作温度 Working Temperature	-25°C~+80°C
防护等级 Protection Degree	IP67
插拔次数 Mating cycles	>500
执行标准 Standard	IEC 61076-2-104

F	防水圈 Seal	FKM Green 氟胶, 绿色	pcs	1
E	线材 Cable	PVC OR PUR	pcs	1
D	成型 Overmold	TPU Black	g	1
C	接触件 Contacts	磷铜镀金, Phosphor copper with AU plated	pcs	3-8
B	胶芯 Insert	尼龙, PA66 Black	pcs	1
A	螺丝 Screw	锌合金镀镍 zinc alloy with nickel plated	pcs	1
编号 No.	品名 Part Name	描述 Description	单位 Unit	用量 Qty

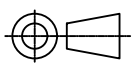

RENHOTEC GROUP

图号 File No.	RHT-M8002	品名 Name	M8 成型式母头 M8 Female Connector, Molded type		
未注公差 Unless Otherwise Specified		单位 Unit	mm	版本 Revision	A/0
线性 Linear	0.5~6	±0.1	比例 Scale	—	 Third Angle Projection
	>6~30	±0.2			
角度 Angles	>30	±2%	页码 Page	1/1	
			图纸确认 DRAWING	日期 Date	
			绘图 Drawing	Ding	2023.05.23
			审核 Checked	Jim	2023.05.23
			客户确认 Customer Approved		